

aiwa

COMPACT DISC STEREO SYSTEM
SISTEMA ESTEREO CON REPRODUCTOR DE DISCOS COMPACTOS
CHAINE STEREO AVEC LECTEUR DE DISQUES COMPACTS

Z-L100

OPERATING INSTRUCTIONS
MANUAL DE INSTRUCCIONES
MODE D'EMPLOI

En (English)

E (Español)

F (Français)

For assistance and information

call toll free 1-800-BUY-AIWA

(United States and Puerto Rico)

WARNING

TO REDUCE THE RISK OF FIRE OR ELECTRIC SHOCK, DO NOT EXPOSE THIS APPLIANCE TO RAIN OR MOISTURE.

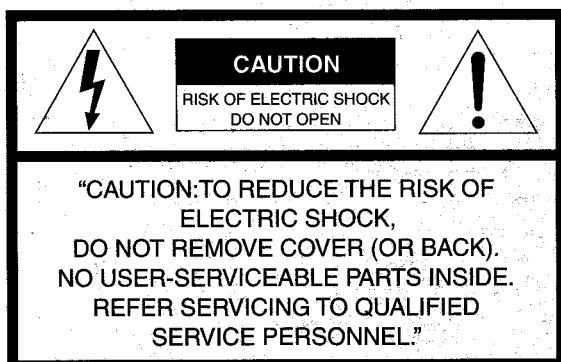

Explanation of Graphical Symbols:



The lightning flash with arrowhead symbol, within an equilateral triangle, is intended to alert the user to the presence of uninsulated "dangerous voltage" within the product's enclosure that may be of sufficient magnitude to constitute a risk of electric shock to persons.



The exclamation point within an equilateral triangle is intended to alert the user to the presence of important operating and maintenance (servicing) instructions in the literature accompanying the appliance.

NOTE

This equipment has been tested and found to comply with the limits for a Class B digital device, pursuant to Part 15 of the FCC Rules. These limits are designed to provide reasonable protection against harmful interference in a residential installation.

This equipment generates, uses, and can radiate radio frequency energy and, if not installed and used in accordance with the instructions, may cause harmful interference to radio communications. However, there is no guarantee that interference will not occur in a particular installation. If this equipment does cause harmful interference to radio or television reception, which can be determined by turning the equipment off and on, the user is encouraged to try to correct the interference by one or more of the following measures:

- Reorient or relocate the receiving antenna.
- Increase the separation between the equipment and receiver.
- Connect the equipment into an outlet on circuit different from that to which the receiver is connected.
- Consult the dealer or an experienced radio/TV technician for help.

CAUTION

Modifications or adjustments to this product, which are not expressly approved by the manufacturer, may void the user's right or authority to operate this product.

PRECAUTIONS

Read the Operating Instructions carefully and completely before operating the unit. Be sure to keep the Operating Instructions for future reference. All warnings and cautions in the Operating Instructions and on the unit should be strictly followed, as well as the safety suggestions below.

Installation

- 1 **Water and moisture** — Do not use this unit near water, such as near a bathtub, washbowl, swimming pool, or the like.
- 2 **Heat** — Do not use this unit near sources of heat, including heating vents, stoves, or other appliances that generate heat. It also should not be placed in temperatures less than 5°C (41°F) or greater than 35°C (95°F).
- 3 **Mounting surface** — Place the unit on a flat, even surface.
- 4 **Ventilation** — The unit should be situated with adequate space around it so that proper heat ventilation is assured. Allow 10 cm (4 in.) clearance from the rear and the top of the unit, and 5 cm (2 in.) from each side.
 - Do not place the unit on a bed, rug, or similar surface that may block the ventilation openings.
 - Do not install the unit in a bookcase, cabinet, or airtight rack where ventilation may be impeded.
- 5 **Objects and liquid entry** — Take care that objects or liquid do not get inside the unit through the ventilation openings.
- 6 **Carts and stands** — When placed or mounted on a stand or cart, the unit should be moved with care. Quick stops, excessive force, and uneven surfaces may cause the unit or cart to overturn or fall.
 
- 7 **Condensation** — Moisture may form on the CD pickup lens when:
 - The unit is moved from a cold spot to a warm spot
 - The heating system has just been turned on
 - The unit is used in a very humid room
 - The unit is cooled by an air conditioner
 When this unit has condensation inside, it may not function normally. Should this occur, leave the unit for a few hours, then try to operate again.
- 8 **Wall or ceiling mounting** — The unit should not be mounted on a wall or ceiling, unless specified in the Operating Instructions.

Electric Power

- 1 **Power sources** — Connect this unit only to power sources specified in the Operating Instructions, and as marked on the unit.
- 2 **Polarization** — As a safety feature, some units are equipped with polarized AC power plugs which can only be inserted one way into a power outlet. If it is difficult or impossible to insert the AC power plug into an outlet, turn the plug over and try again. If it is not still inserted easily into the outlet, please call a qualified service technician to service or replace the outlet. To avoid defeating the safety feature of the polarized plug, do not force it into a power outlet.

3 AC power cord

- When disconnecting the AC power cord, pull it out by the AC power plug. Do not pull the cord itself.
- Never handle the AC power plug with wet hands, as this could result in fire or shock.
- Power cords should be firmly secured to avoid being severely bent, pinched, or walked upon. Pay particular attention to the cord from the unit to the power outlet.
- Avoid overloading AC power plugs and extension cords beyond their capacity, as this could result in fire or shock.

4 Extension cord — To help prevent electric shock, do not use a polarized AC power plug with an extension cord, receptacle, or other outlet unless the polarized plug can be completely inserted to prevent exposure of the blades of the plug.

5 When not in use — Unplug the AC power cord from the power outlet if the unit will not be used for several months or more. When the cord is plugged in, a small amount of current continues to flow to the unit, even when the power is turned off.

Outdoor Antenna

- 1 Power lines** — When connecting an outdoor antenna, make sure it is located away from power lines.
- 2 Outdoor antenna grounding** — Be sure the antenna system is properly grounded to provide protection against unexpected voltage surges or static electricity build-up. Article 810 of the National Electrical Code, ANSI/NFPA 70, provides information on proper grounding of the mast, supporting structure, and the lead-in wire to the antenna discharge unit, as well as the size of the grounding unit, connection to grounding terminals, and requirements for grounding terminals themselves.

Antenna Grounding According to the National Electrical Code

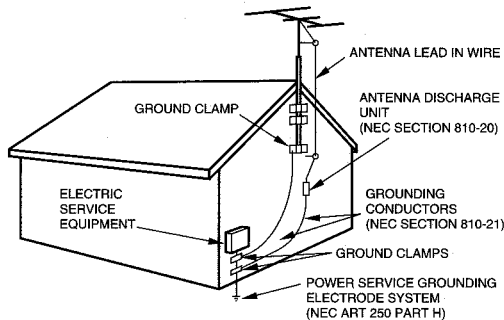

NEC-NATIONAL ELECTRICAL CODE

Maintenance

Clean the unit only as recommended in the Operating Instructions.

Damage Requiring Service

Have the units serviced by a qualified service technician if:

- The AC power cord or plug has been damaged
- Foreign objects or liquid have got inside the unit
- The unit has been exposed to rain or water
- The unit does not seem to operate normally
- The unit exhibits a marked change in performance
- The unit has been dropped, or the cabinet has been damaged

DO NOT ATTEMPT TO SERVICE THE UNIT YOURSELF

TABLE OF CONTENTS

PREPARATIONS

CONNECTIONS	3
REMOTE CONTROL	4
BEFORE OPERATION	5

SOUND

AUDIO ADJUSTMENTS	6
GRAPHIC EQUALIZER	7

RADIO RECEPTION

MANUAL TUNING	7
PRESETTING STATIONS	8

TAPE PLAYBACK

BASIC OPERATIONS	8
------------------------	---

CD PLAYING

BASIC OPERATIONS	9
PROGRAMMED PLAY	10

RECORDING

BASIC RECORDING	11
AI EDIT RECORDING	12
PROGRAMMED EDIT RECORDING	13

CLOCK AND TIMER

SETTING THE CLOCK	14
SETTING THE SLEEP TIMER	14
SETTING THE TIMER	15

TURNTABLE

BASIC OPERATIONS	16
------------------------	----

OTHER CONNECTIONS

CONNECTING OPTIONAL EQUIPMENT	16
LISTENING TO EXTERNAL SOURCES	17

GENERAL

CARE AND MAINTENANCE	17
TROUBLESHOOTING GUIDE	18
SPECIFICATIONS	18

PARTS INDEX	Back cover
-------------------	------------

Owner's record

For your convenience, record the model number and serial number (you will find them on the rear of your unit) in the space provided below. Please refer to them when you contact your Aiwa dealer in case of difficulty.

Model No.	Serial No. (Lot No.)
CX-ZL100	
SX-ZL100	
PX-E860	

CONNECTIONS

Check your system and accessories

- CX-ZL100 Compact disc stereo cassette receiver
- SX-ZL100 Front speakers
- PX-E860 Stereo turntable

Remote control AM antenna FM antenna

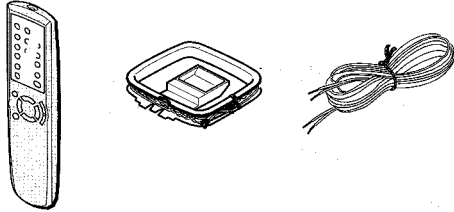

Operating Instructions, etc.

IMPORTANT

- Connect the speakers, antennas, and all optional equipment first. Then connect the AC cord.
- There are no difference between the front speakers. Both speakers can be connected as L (left) or R (right).

Before connecting the AC cord

The rated voltage of your unit shown on the rear panel is 120 V AC. Check that the rated voltage matches your local voltage.

1 Connect the right and left speakers to the main unit.

Connect the right speaker cord to **SPEAKERS R** terminals, and left to **SPEAKERS L** terminals.

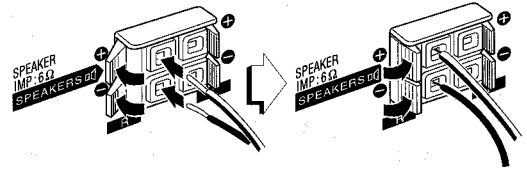

The speaker cord with the white stripe should be connected to **+** terminal and the black cord to **-** terminal.

2 Connect the stereo turntable to the main unit.

Connect the red plug to **VIDEO/AUX/PHONO IN R** jack, and the white plug to **VIDEO/AUX/PHONO IN L** jack.

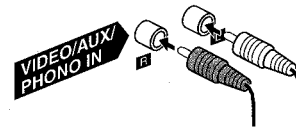

3 Connect the supplied antennas.

Connect the FM antenna to **FM 75 Ω** terminals and the AM antenna to **AM LOOP** terminals.

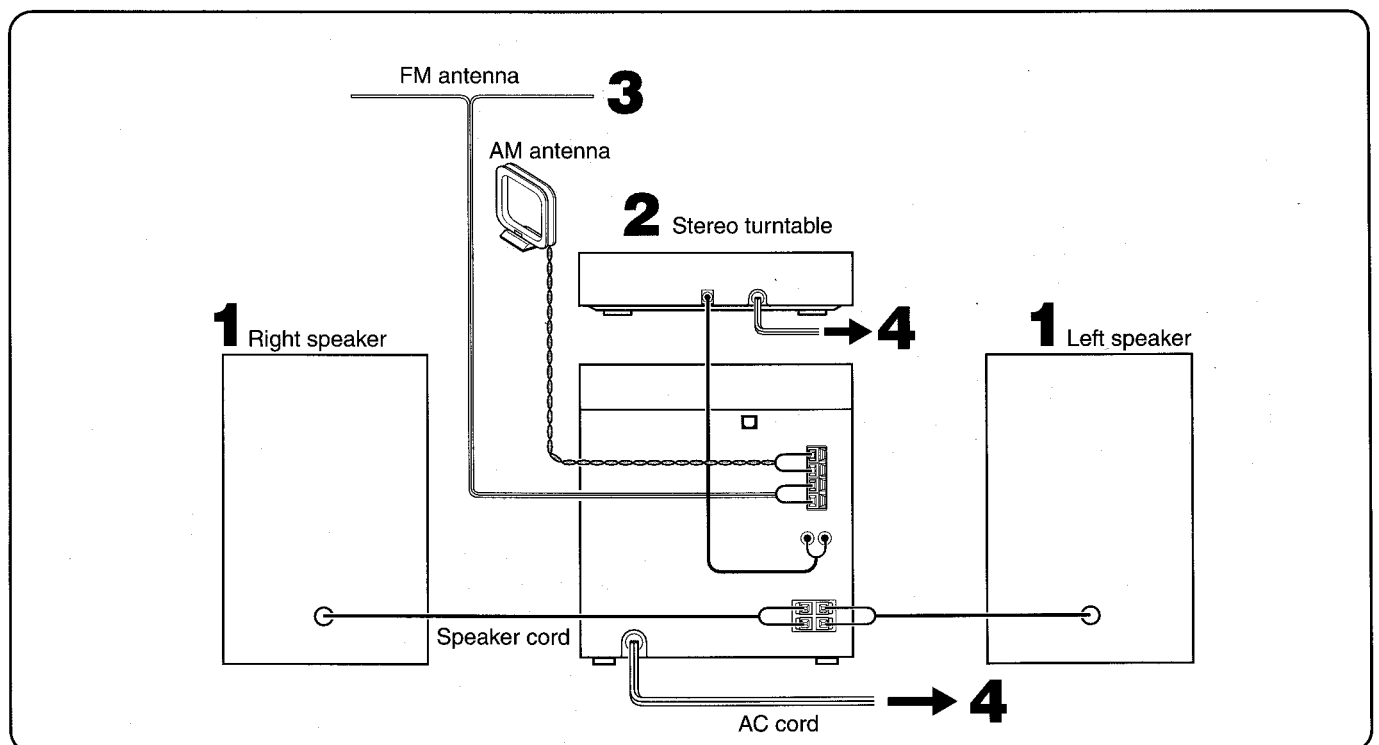
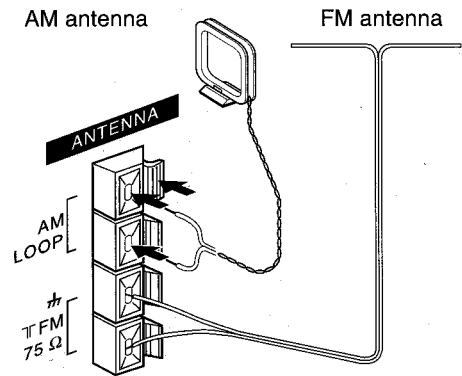

4 Connect the AC cord to an AC outlet.

To position the antennas

FM antenna:

Extend the antenna horizontally in a T-shape and fix its ends to the wall.

AM antenna:

Position to find the best reception.

To stand the AM antenna on a surface

Fix the claw to the slot.

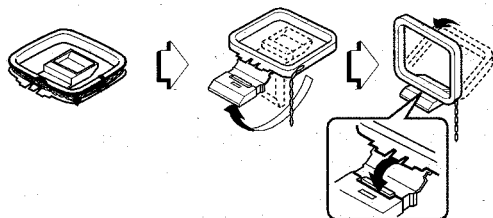

NOTE

- Be sure to connect the speaker cords correctly. Improper connections can cause short circuits in **SPEAKERS** terminals.

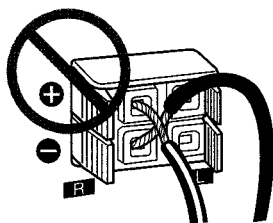

- Do not leave objects generating magnetism, such as credit cards, near the speakers, as the objects may be damaged.
- Do not bring the FM antenna near metal objects or curtain rails.
- Do not bring the AM antenna near other optional equipment, the stereo system itself, the AC cord or speaker cords, since noise will be picked up.
- Do not unwind the AM antenna wire.

CONNECTING AN OUTDOOR ANTENNA

For better FM reception, use of an outdoor antenna is recommended.

Connect the outdoor antenna to **FM 75 Ω** terminals.

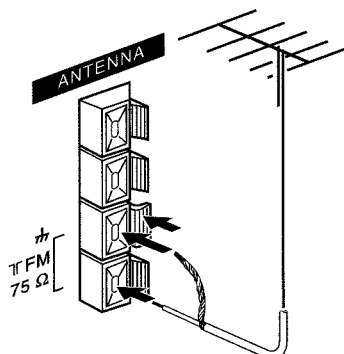

To connect other optional equipment → page 16.

REMOTE CONTROL

Inserting batteries

Detach the battery cover on the rear of the remote control and insert two size AA (R6) batteries.

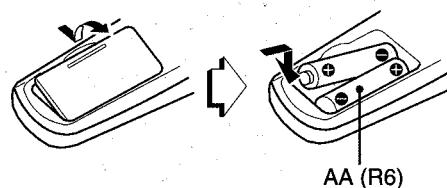

When to replace the batteries

The maximum operational distance between the remote control and the sensor on the main unit should be approximately 5 meters (16 feet). When this distance decreases, replace the batteries with new ones.

To use SHIFT on the remote control

Buttons ① have two different functions. One of these functions is indicated on the button, and the other on the plate above the button.

To use the function on the button, simply press the button.

To use the function on the plate above the button, press the button while pressing **SHIFT**.

To use FUNCTION on the remote control

FUNCTION substitutes for the function buttons (**TAPE, TUNER/BAND, VIDEO/AUX/PHONO, CD**) on the main unit.

Each time **FUNCTION** is pressed, the next function is selected cyclically.

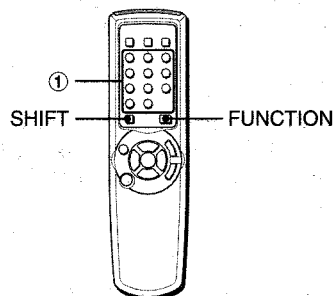

NOTE

- If the remote control is not going to be used for an extended period of time, remove the batteries to prevent possible electrolyte leakage.
- The remote control may not operate correctly when:
 - The line of sight between the remote control and the remote sensor inside the display window is exposed to intense light, such as direct sunlight.
 - Other remote controls are used nearby (those of a television, etc.).

BEFORE OPERATION

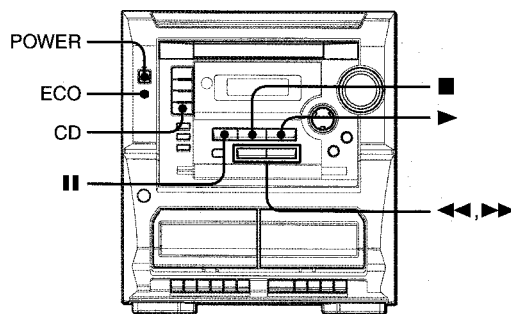

To turn the unit on

Press one of the function buttons (**TAPE, TUNER/BAND, VIDEO/AUX/PHONO, CD**). Playback of the inserted disc begins, or the previously tuned station is received (Direct Play Function).

POWER is also available.

When the unit is turned on, the disc compartment may open and close to reset the unit.

To turn the unit off

Press **POWER**.

If the power is turned off after the clock is set

Nothing is displayed on the display window. The red indicator above the power button lights up to indicate that power is supplied.

DEMO (Demonstration) mode

When the AC cord is connected, the display window demonstrates the functions of the unit. When the power is turned on, the DEMO display is overridden by the operation display. When the power is turned off, the DEMO mode is restored.

To cancel DEMO mode

Press **|| SET** while the power is off. The clock appears on the display. (To set the current time, see "SETTING THE CLOCK" on page 14.) To re-activate DEMO mode, press **▶** while the power is off.

To change the brightness level of the display

- 1 Press **ECO** twice so that "DIM MODE" is displayed.
- 2 Within 4 seconds, press **||**.
- 3 Within 4 seconds, press **◀◀** or **▶▶** repeatedly to select the dimmer mode as below.

▶ **DIM-OFF** ◀◀ **DIMMER 1** ◀◀ **DIMMER 2** ◀◀ **DIMMER 3** ◀◀

"DIM-OFF" mode is the brightest and "DIMMER 3" mode is the dimmest.

- 4 Within 4 seconds, press **||** to set the selected mode.

SETTING POWER ECONOMIZING MODE

When you set power economizing mode to "ECO ON" or "ECO AUTO", the unit reduces power consumption by conducting four ECO operations as follows.

- The unit (all the illumination of the display) blacks out when the power is turned off. Only the red indicator lights up.
→ If the clock is not set, the unit does not black out. Instead, the DEMO will begin when the power is turned off.
- The illumination of the display brighten for 10 seconds only when you press a button, or turn **VOLUME**.
→ If the display dimmer mode is set to "DIM-OFF", the brightness of the illumination does not change.
- The display dimmer mode is set to the dimmest, and the volume is set to the minimum (0) when the unit turns on by timer recording.
- The unit automatically turns itself off if you do not use it for 10 minutes. (only when "ECO AUTO" is selected)
→ The unit does not turn itself off if there is audio input signal through **VIDEO/AUX/PHONO IN** jacks when the function is VIDEO/AUX/PHONO.

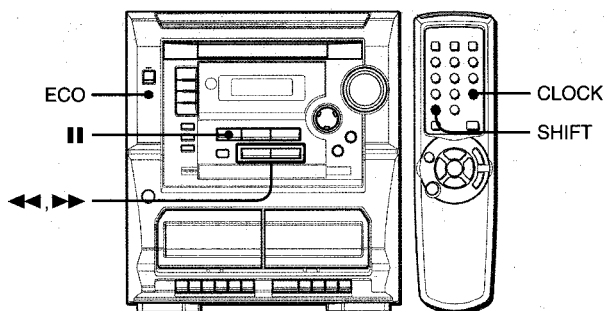

1 Press ECO once.

"ECO MODE" will be displayed.

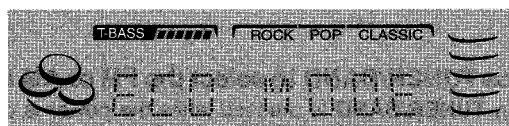

2 Press II within 4 seconds.

The current power-economizing mode status will be displayed.

If the power-economizing mode is off: ECO OFF.

If the power-economizing mode is on: ECO ON or ECO AUTO.

3 Within 4 seconds, press ◀◀ or ▶▶ repeatedly to select the power-economizing mode.

Example: When "ON" is selected.

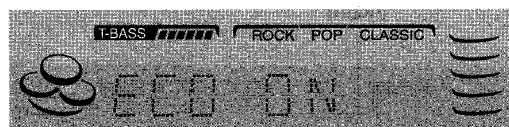

4 Press II within 4 seconds to set the mode.

NOTE

To view the clock when all the display lights turn off, press **CLOCK** on the remote control while pressing **SHIFT** so that the time is displayed for 4 seconds.

When using the main unit, press **II SET**.

Standby power consumption

If the power-economizing mode is OFF: 15W

If the power-economizing mode is AUTO or ON: 0.9W

AUDIO ADJUSTMENTS

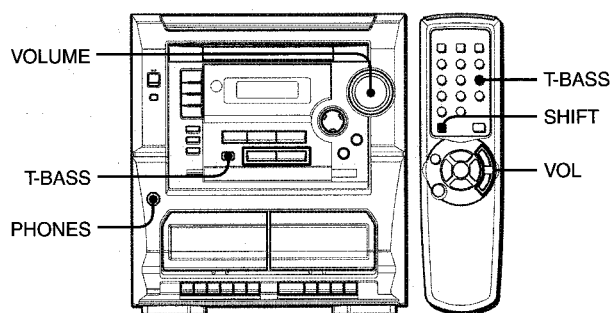

VOLUME CONTROL

Turn **VOLUME** on the main unit, or press **VOL** \wedge or \vee on the remote control.

The volume level is displayed as a number from 0 to MAX (31). The volume level is automatically set to 16 when the power is turned off with the volume level set to 17 or more.

SUPER T-BASS SYSTEM

The T-BASS system enhances the realism of low-frequency sound.

Press T-BASS.

Each time it is pressed, the level changes. Select one of the three levels or the off position to suit your preference.

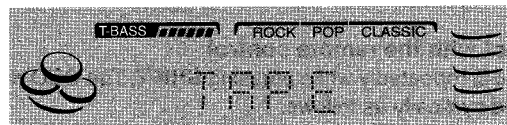

To select with the remote control

Press **T-BASS** while pressing **SHIFT**.

NOTE

Low frequency sound may be distorted when the T-BASS system is used for a disc or tape in which low frequency sound is already emphasized. In this case, cancel the T-BASS system.

Using the headphones

Connect headphones to **PHONES** jack with a standard stereo plug ($\phi 6.3$ mm, 1/4 inch).

No sound is output from the speakers while the headphones are plugged in.

GRAPHIC EQUALIZER

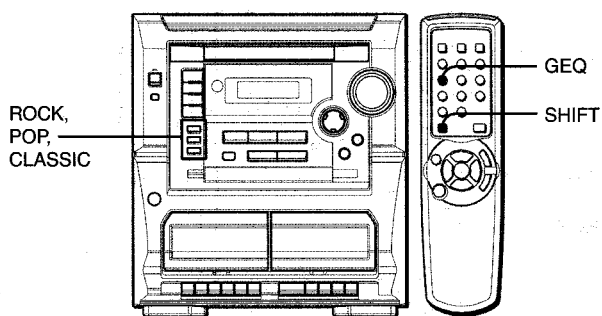

This unit provides the following three different equalization curves.
ROCK: Powerful sound emphasizing treble and bass
POP: More presence in the vocals and midrange
CLASSIC: Enriched sound with heavy bass and fine treble.

Press one of the graphic equalizer buttons (ROCK, POP, CLASSIC).

The selected equalization mode is displayed.



To cancel the selected mode

Press the selected button again. "GEQ OFF" is displayed.

To select with the remote control

Press **GEQ** repeatedly while pressing **SHIFT**. The GEQ mode is displayed cyclically as follows.

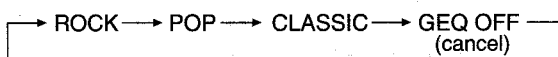

MANUAL TUNING

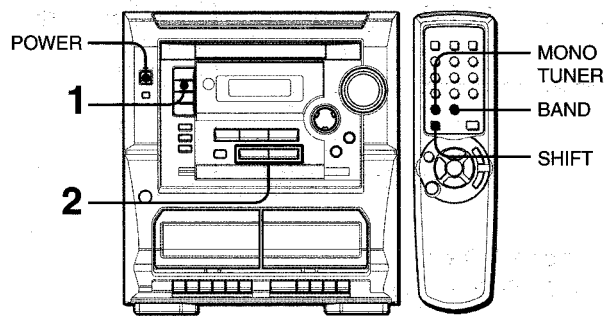

1 Press TUNER/BAND to select the FM or AM band.

When **TUNER/BAND** is pressed while the power is off, the power is turned on directly (Direct Play Function).

To select a band with the remote control

Press **BAND** while pressing **SHIFT**.

2 Press ◀◀DOWN or ▶▶UP to select a station.

Each time the button is pressed, the frequency changes.

When a station is received, "TUNE" is displayed for 2 seconds. During FM stereo reception, ((Ⓜ)) is displayed.

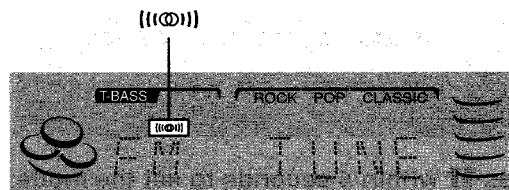

To search for a station quickly (Auto Search)

Keep ◀◀DOWN or ▶▶UP pressed until the frequency starts to change rapidly. After tuning in to a station, the search stops. To stop the Auto Search manually, press ◀◀DOWN or ▶▶UP.

- The Auto Search may not stop at stations with very weak signals.

When an FM stereo broadcast contains noise

Press **MONO TUNER** on the remote control while pressing **SHIFT** so that "MONO" appears on the display.

Noise is reduced, although reception is monaural.

To restore stereo reception, press **MONO TUNER** on the remote control while pressing **SHIFT** so that "STEREO" appears.

To change the AM tuning interval

The default setting of the AM tuning interval is 10 kHz/step. If you use this unit in an area where the frequency allocation system is 9 kHz/step, change the tuning interval.

Press **POWER** while pressing **TUNER/BAND** on the unit.

To reset the interval, repeat this procedure.

NOTE

When the AM tuning interval is changed, all preset stations are cleared. The preset stations have to be set again.

PRESETTING STATIONS

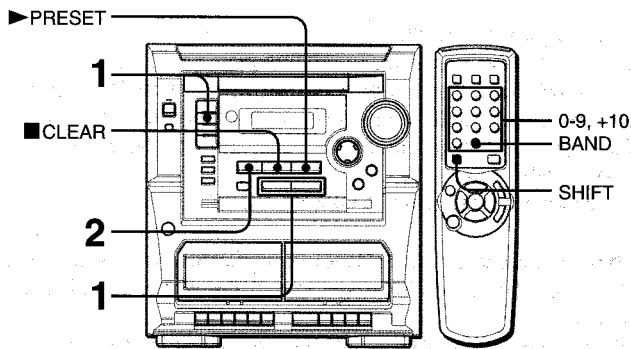

The unit can store a total of 32 preset stations. When a station is stored, a preset number is assigned to the station. Use the preset number to tune in to a preset station directly.

1 Press TUNER/BAND to select a band, and press ◀◀DOWN or ▶▶UP to select a station.

2 Press ■SET to store the station.

A preset number beginning from 1 in consecutive order for each band is assigned to the station.

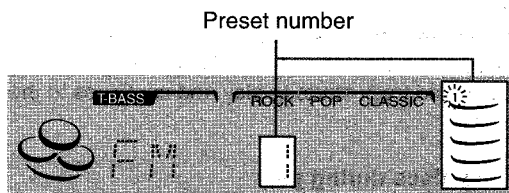

3 Repeat steps 1 and 2.

No more stations will be stored if a total of 32 preset stations have already been stored.

NOTE

"FULL" is displayed if you attempt to store more than 32 preset stations.

PRESET NUMBER TUNING

Use the remote control to select the preset number directly.

1 Press BAND while pressing SHIFT to select a band.

2 Press numbered buttons 0-9 and +10 to select a preset number.

Example:

To select preset number 20, press +10, +10 and 0.

To select preset number 15, press +10 and 5.

Selecting a preset number on the main unit

Press TUNER/BAND to select a band. Then, press ►PRESET repeatedly.

Each time ►PRESET is pressed, the next ascending number is selected.

To clear a preset station

Select the preset number of the station to be cleared. Then, press ■CLEAR, and press ■SET within 4 seconds.

The preset numbers of all other stations in the band with higher numbers are decreased by one.

BASIC OPERATIONS

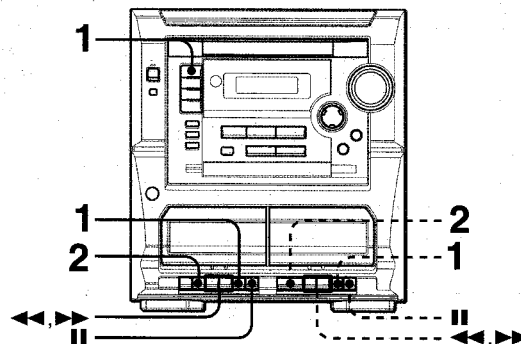

Use Type I (normal) tapes only.

1 Press TAPE, then press ■/▲ to open the cassette holder.

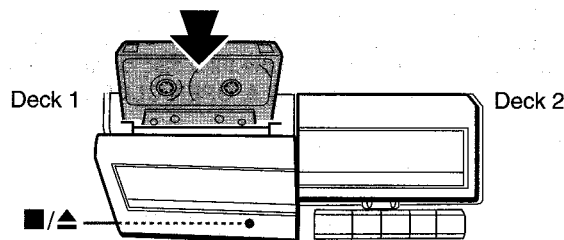

Insert a tape with the exposed side down. Push the cassette holder to close.

2 Press ► to start play.

Only the side facing out from the unit can be played back.

To stop play, press ■/▲.

To pause play, press ■■. To resume play, press again.

To fast forward or rewind, press ◀◀ or ▶▶ in stop mode. Then press ■/▲ to stop the tape.

When both deck 1 and deck 2 are set in the playback mode

Deck 2 is heard.

BASIC OPERATIONS

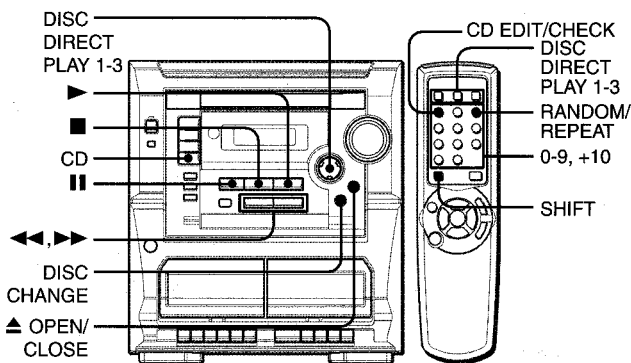

LOADING DISCS

Press **CD**, then press **▲ OPEN/CLOSE** to open the disc compartment. Load disc(s) with the label side up.

To load one or two discs, place the discs on tray 1 and 2.
To load three discs, press **DISC CHANGE** to rotate the trays after placing two discs. Place the third disc on tray 3. Close the disc compartment by pressing **▲ OPEN/CLOSE**.

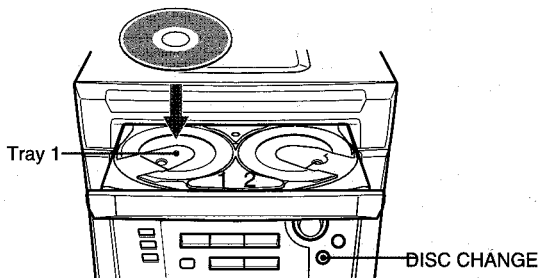

Tray number of the disc to be played

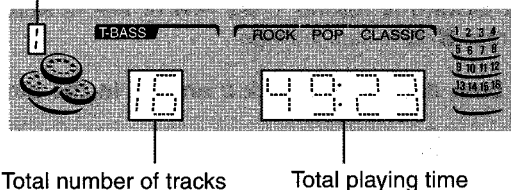

PLAYING DISCS

Load discs.

To play all discs in the disc compartment, press **▶**. Play begins with the disc on tray 1.

Number of track being played

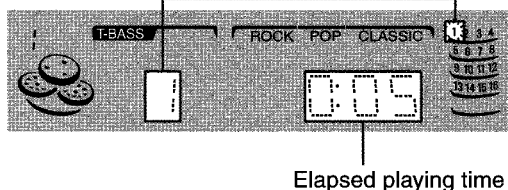

To play one disc only, press one of **DISC DIRECT PLAY 1-3**.

The selected disc is played once.

To stop play, press **■**.

To pause play, press **II**. To resume play, press again.

To search for a particular point during playback, keep **◀** or **▶** pressed and release the button at the desired point.

To skip to the beginning of a track during playback, press **◀** or **▶** repeatedly.

To remove discs, press **▲ OPEN/CLOSE**.

To start play when the power is off (Direct Play Function)
 Press **CD**. The power is turned on and play of the loaded disc(s) begins.

When **▲ OPEN/CLOSE** is pressed, the power is also turned on and the disc compartment is opened.

To check the remaining time

During play, press **CD EDIT/CHECK** on the remote control while pressing **SHIFT**. The amount of time remaining until all tracks finish playing is displayed. To restore the playing time display, repeat the above.

Selecting a track with the remote control

- 1 Press one of **DISC DIRECT PLAY 1-3** to select a disc.
- 2 Press numbered buttons **0-9** and **+10** to select a track.

Example:

To select the 25th track, press **+10**, **+10** and **5**.

To select the 10th track, press **+10** and **0**.

The selected track starts to play and continues to the end of that disc.

Replacing discs during play

While one disc is playing, the other discs can be replaced without interrupting play.

- 1 Press **DISC CHANGE**.
- 2 Remove the discs and replace with other discs.
- 3 Press **▲ OPEN/CLOSE** to close the disc compartment.

NOTE

- When loading an 8-cm (3-inch) disc, make sure to place it onto the inner circle of the tray precisely.
- Do not place more than one compact disc on one disc tray.
- Do not tilt the unit with discs loaded. Doing so may cause malfunctions.
- When transporting the unit, remove the discs from the trays.
- Do not use irregular shape CDs (example: heart-shaped, octagonal ones). It may result in malfunctions.

RANDOM/REPEAT PLAY

Use the remote control.

RANDOM play

All the tracks on the selected disc or all the discs can be played randomly.

REPEAT play

A single disc or all the discs can be played repeatedly.

Press RANDOM/REPEAT while pressing SHIFT.

Each time it is pressed, the function can be selected cyclically.

RANDOM play — RANDOM lights up on the display.

REPEAT play —  lights up on the display.

RANDOM/REPEAT play — RANDOM and  light up on the display.

Cancel — RANDOM and  disappear from the display.

To play all discs, press  to start play.

To play a single disc, press one of **DISC DIRECT PLAY 1-3** to start play.

NOTE

During random play it is not possible to skip to the previously played track with .

3 Press numbered buttons 0-9 and +10 to program a track.

Example:

To select the 25th track, press +10, +10 and 5.

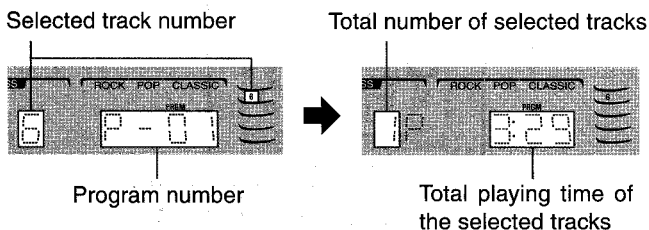

To select the 10th track, press +10 and 0.



4 Repeat steps 2 and 3 to program other tracks.

5 Press to start play.

To check the program

Each time  or  is pressed in stop mode, a disc number, track number, and program number will be displayed.

To clear the program

Press  **CLEAR** in stop mode.

To add tracks to the program

Repeat steps 2 and 3 in stop mode. The track will be programmed after the last track.

To change the programmed tracks

Clear the program and repeat all the steps again.

To play the programmed tracks repeatedly

After programming the tracks, press **RANDOM/REPEAT** repeatedly while pressing **SHIFT** until  appears on the display.

NOTE

- During programmed play, you can not use random play, check the remaining time or select a track.
- "FULL" is displayed if you attempt to program more than 30 tracks.

PROGRAMMED PLAY

Up to 30 tracks can be programmed from any of the inserted discs.

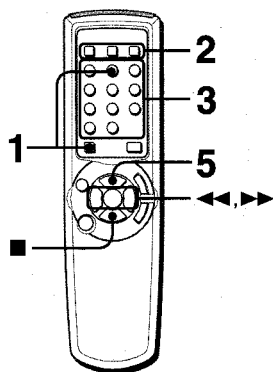

Use the remote control.

1 Press PRGM while pressing SHIFT in stop mode.

"PRGM" is displayed.

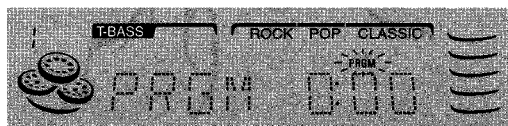

2 Press one of DISC DIRECT PLAY 1-3 to select a disc.

Go to the next step when the tray stops rotating.

BASIC RECORDING

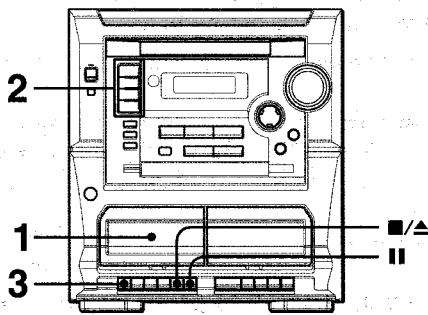

Preparation

- Use Type I (normal) tapes only.
- Set the tape to the point where recording will start.
- Note that recording is done on only one side of the tape.

1 Insert the tape to be recorded on into deck 1.

Insert the tape with the side to be recorded on first facing out from the unit.

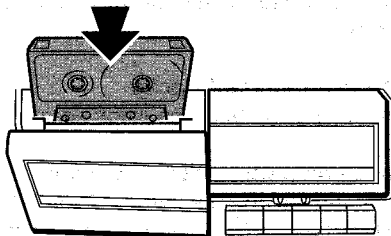

2 Press one of the function buttons and prepare the source to be recorded.

- To record from a CD, press **CD** and load the disc(s).
- To record from a tape, press **TAPE**. Then, insert the original tape into deck 2 and play it.
- To record from a radio broadcast, press **TUNER/BAND** and tune in to a station.
- To record from a connected source, press **VIDEO/AUX/PHONO** and play.

3 Press ● on deck 1 to start recording.

▶ is depressed simultaneously. When the selected function is CD, playback and recording start simultaneously.

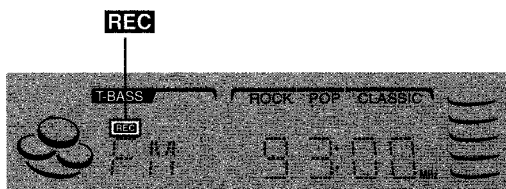

- To stop recording, press ■/▲ on deck 1.
- To pause recording, press || on deck 1.
- To resume recording, press it again.

To record selected tracks of the CD

Before pressing ●, program the tracks (see page 10).

To record part of the CD

When ● is pressed, recording always starts from the first track. To start in the middle of a track, play the CD first and press **IISET** for CD at the point you wish to start recording from. Then, press ●. The pause mode for CD button is released automatically and recording starts.

Sound adjustment during recording

The output volume and tone of the speakers or headphones are freely varied without affecting the recording.

NOTE

- Do not press the buttons on deck 2 during recording.
- ● cannot be depressed if the erasure prevention tab on the side of the tape to be recorded is broken off.

To erase a recording

A previous recording is erased when a new recording is made on that part of that tape.

- 1 Insert the tape you want to erase into deck 1.
- 2 Press **TAPE** and stop all the tape operation in deck 2.
- 3 Wind up the tape to the point where the erasure is to be started.
- 4 Press ● on deck 1 to start the erasure.

About cassette tapes

- To prevent accidental erasure, break off the plastic tabs on the cassette tape after recording with a screwdriver or other pointed tool.

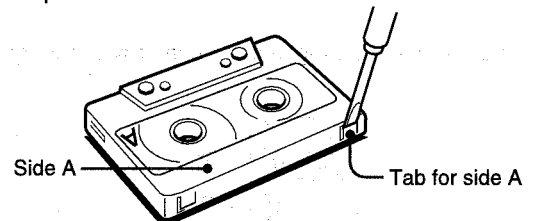

To record on the tape again, cover the tab openings with adhesive tape, etc.

- 120-minute or longer tapes are extremely thin and easily deformed or damaged. They are not recommended.
- Take up any slack in the tape with a pencil or similar tool before use. Slack tape may break or jam in the mechanism.

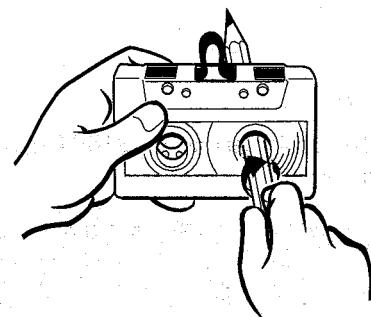

COPYRIGHT

Please check the laws on copyright relating to recordings from discs, radio or external tape for the country in which the machine is being used.

AI EDIT RECORDING

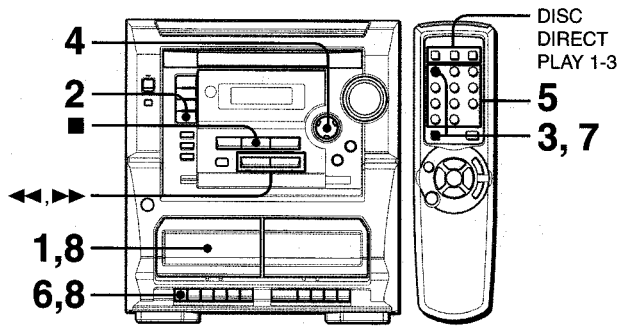

The AI edit recording function enables CD recording without worrying about tape length and track length. When a CD is inserted, the unit automatically calculates the total track length. If necessary, the order of tracks is rearranged so that no track is cut short.

(AI: Artificial Intelligence)

1 Insert the tape into deck 1.

Insert the tape with the side to be recorded on first facing out from the unit, and wind up the tape with ◀▶.

2 Press CD and load the disc(s).

3 Press CD EDIT/CHECK once while pressing SHIFT on the remote control.

"EDIT" and "AI" are displayed.

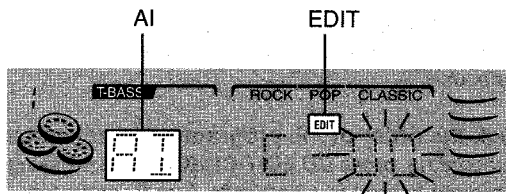

• When "PRGM" is displayed, press CD EDIT/CHECK while pressing SHIFT again.

4 Press one of DISC DIRECT PLAY 1-3 to select a disc.

5 Press numbered buttons 0-9 on the remote control to designate the tape length.

10 to 99 minutes can be specified.

Example: When using a 60-minute tape, press 6 and 0.

In a few seconds, the tracks to be recorded on each side of the tape are determined.

• ◀▶ and ▶▶ are also available to designate the tape length.

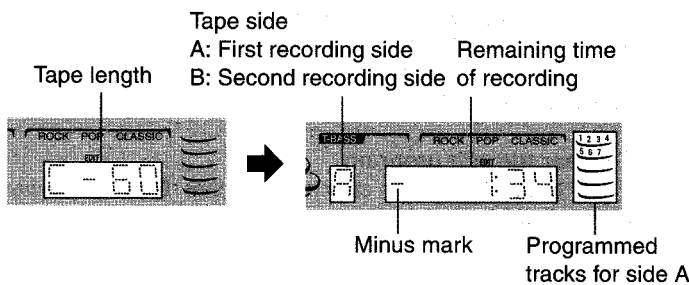

6 Press ● on deck 1 to start recording on the first side.

REC flashes for 10 seconds, and then CD play and recording of edited tracks for the first side start simultaneously. When the end of the tape is reached, deck 1 enters the recording stop mode. After entering the recording stop mode go to step 7.

7 Press CD EDIT/CHECK while pressing SHIFT on the remote control to display the program for the second recording.

"B" is displayed.

8 Turn over the tape in deck 1 and press ● to start recording on the second side.

To stop recording

Press ■/▲ on deck 1.

Recording and CD play stop simultaneously.

To clear the edit program

Press ■CLEAR twice in the stop mode so that "EDIT" disappears on the display, or press ▲OPEN/CLOSE.

To check the order of the programmed track numbers

Before recording, press CD EDIT/CHECK while pressing SHIFT on the remote control to select side A or B, and press ◀▶ or ▶▶ repeatedly.

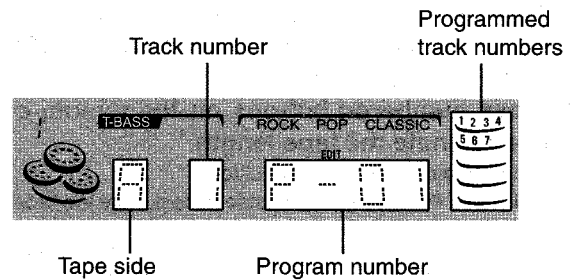

To add tracks from other discs to the edit program

If there is any time remaining on the tape after step 5, you can add tracks from other discs in the CD compartment.

1 Press CD EDIT/CHECK while pressing SHIFT on the remote control to select side A or B.

2 Press one of DISC DIRECT PLAY 1-3 to select a disc.

3 Press numbered buttons on the remote control to select tracks.

A track whose playing time is longer than the remaining time cannot be programmed.

4 Repeat steps 2 and 3 to add more tracks.

Time on cassette tapes and editing time

The actual cassette recording time is usually a little longer than the specified recording time printed on the label. This unit can program tracks to use the extra time. When the total recording time is a little longer than the tape's specified recording time after editing, the display shows the extra time (without a minus mark), instead of the time remaining on the tape (with the minus mark).

NOTE

- Recording is inhibited if the erasure prevention tab for the side of the tape facing out from the unit is broken off.
- The AI edit recording function cannot be used with discs containing 31 tracks or more. "TR OVER" is displayed if this is attempted.

PROGRAMMED EDIT RECORDING

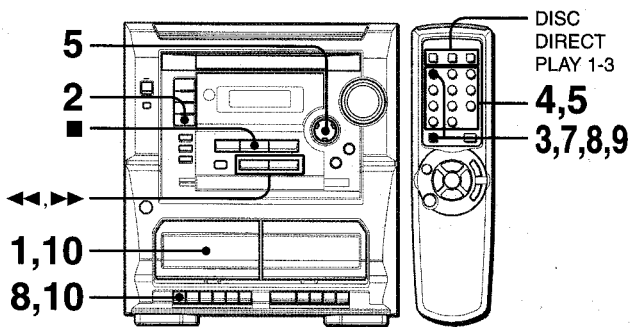

In the programmed edit recording function the tracks can be programmed while checking the remaining time on each side of the tape as the tracks are programmed.

1 Insert the tape into deck 1.

Insert the tape with the side to be recorded on first facing out from the unit, and wind up the tape with ◀◀.

2 Press CD and load the disc(s).

3 Press CD EDIT/CHECK twice while pressing SHIFT on the remote control.

"EDIT" and "PRGM" are displayed.

- When "AI" is displayed, press CD EDIT/CHECK while pressing SHIFT again.

4 Press numbered buttons on the remote control to designate the tape length.

10 to 99 minutes can be specified.

- ◀◀ and ▶▶ are also available to designate the tape length.

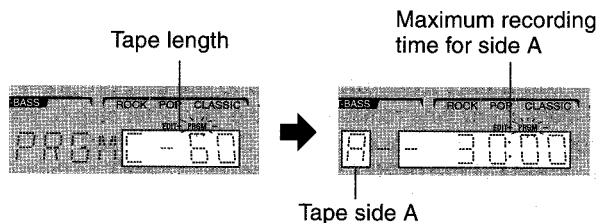

5 Press one of DISC DIRECT PLAY 1-3 to select a disc.

Then, press numbered buttons 0-9 and +10 on the remote control to program a track.

Example: To select the 10th track of disc 2, press DISC DIRECT PLAY 2, then press +10 and 0.

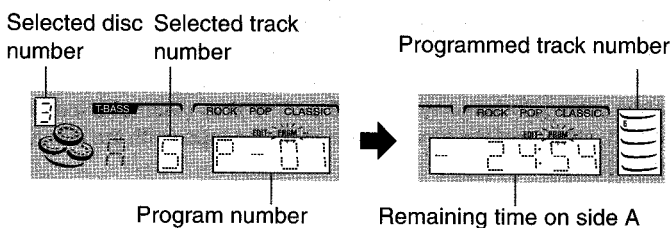

6 Repeat step 5 for the rest of the tracks for side A.

A track whose playing time is longer than the remaining time cannot be programmed.

7 Press CD EDIT/CHECK while pressing SHIFT on the remote control to select side B and program the tracks for side B.

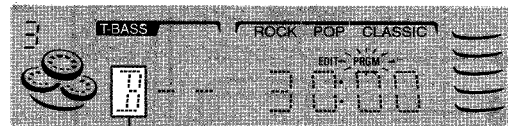

Tape side B (reverse side)

8 Press CD EDIT/CHECK while pressing SHIFT to select side A and press ● on deck 1.

REC flashes for 10 seconds, and then CD play and recording of edited tracks for the first side start simultaneously. When the end of the tape is reached, deck 1 enters the recording stop mode. After entering the recording stop mode, go to step 9.

9 Press CD EDIT/CHECK while pressing SHIFT on the remote control for recording of the second side.

"B" is displayed.

10 Turn over the tape in deck 1 and press ● to start recording.

Recording starts.

To stop recording

Press ■/▲ on deck 1. Recording and CD play stop simultaneously.

To check the order of the programmed track numbers

Before recording, press CD EDIT/CHECK while pressing SHIFT on the remote control to select side A or B, and press ◀◀ or ▶▶ repeatedly.

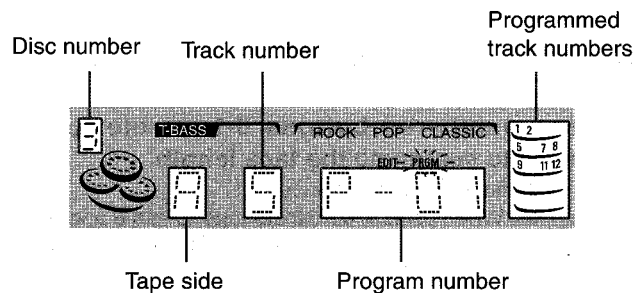

To change the program of each side

Press CD EDIT/CHECK while pressing SHIFT on the remote control to select side A or B, and press ■ CLEAR to clear the program on the selected side. Then program tracks again.

To clear the edit program

Press ■ CLEAR twice in stop mode so that "EDIT" disappears on the display.

NOTE

- Recording is inhibited if the erasure prevention tab for the side of the tape facing out from the unit is broken off.
- Up to 30 tracks can be programmed from any of the inserted discs.
- "FULL" is displayed if you attempt to program more than 30 tracks.

SETTING THE CLOCK

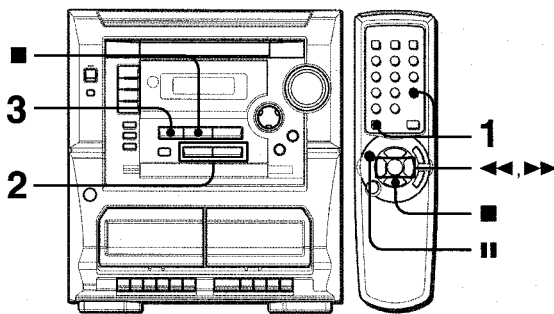

When the clock is set, the “:” between the hours and minutes flashes. When the clock setting is canceled due to a power failure, the entire clock display flashes.

Use the remote control.

- 1 Press CLOCK once while pressing SHIFT on the remote control.**

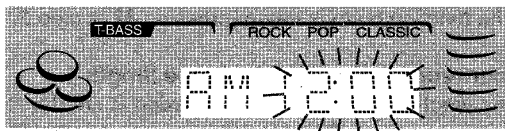

- 2 Within 4 seconds, press ◀◀ or ▶▶ to designate the hour and the minute.**

Holding these buttons down will vary the time rapidly.

- 3 Press ■.**

The clock starts from 00 seconds.

To view the clock when another display is in the display
Press **CLOCK** while pressing **SHIFT**. The time is displayed for 4 seconds and then the original display reappears. However, the clock cannot be displayed during recording.

To switch to the 24-hour standard

Press **CLOCK** once while pressing **SHIFT** and then press ■ within 4 seconds.

Repeat the same procedure to restore the 12-hour standard.

If the clock display flashes

If the display flashes when the clock is displayed, it indicates that the clock has stopped due to a power failure or the removal of the power cord. The current time needs to be reset.

SETTING THE SLEEP TIMER

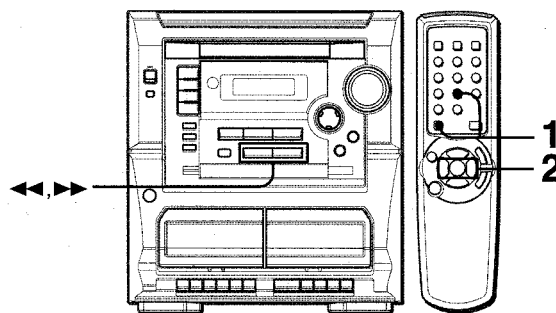

The unit can be turned off automatically at a specified time.

Use the remote control.

- 1 Press SLEEP while pressing SHIFT on the remote control.**

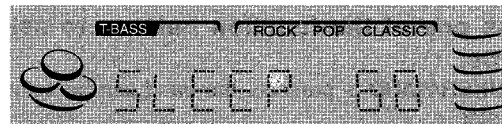

- 2 Within 4 seconds, press ◀◀ or ▶▶ to specify the time until the power is turned off.**

The time changes between 5 and 240 minutes in 5-minute steps.

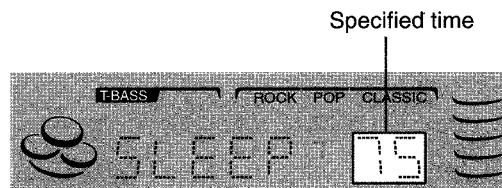

While the sleep timer is in operation, the display is dimmer than usual.

To check the time remaining until the power is turned off

Press **SLEEP** once while pressing **SHIFT**. The remaining time is displayed for 4 seconds.

To cancel the sleep timer

Press **SLEEP** twice while pressing **SHIFT** so that “SLEEPoFF” appears on the display.

SETTING THE TIMER

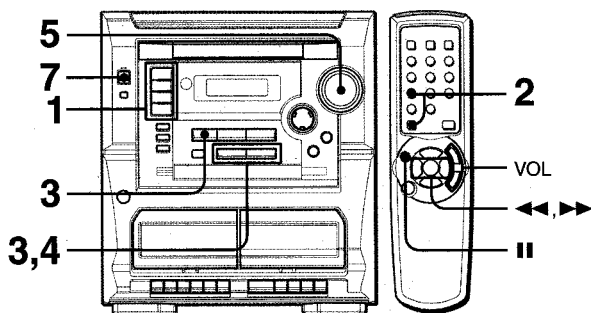

The unit can be turned on at a specified time every day with the built-in timer.

Preparation

Make sure the clock is set correctly.

1 Press one of the function buttons to select a source.

- If **TUNER/BAND** is pressed, the band can be selected in this step.

2 Press **TIMER** while pressing **SHIFT** on the remote control until ☉ and "⏰ TIMER" appear on the display.

Time and audio source name flash alternately.

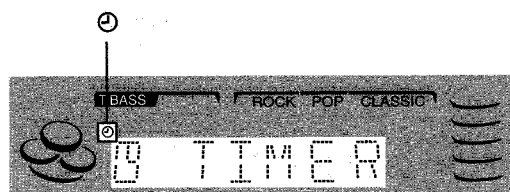

3 Within 6 seconds, press ◀ or ▶ to designate the timer-on time, then press II.

Holding these buttons down will vary the time rapidly.

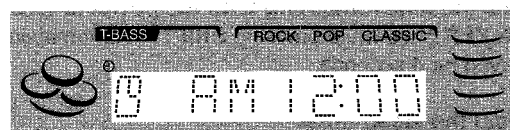

4 Within 4 seconds, press ◀ or ▶ to select the duration for the timer-activated period.

The duration can be set between 5 and 240 minutes in 5-minute steps.

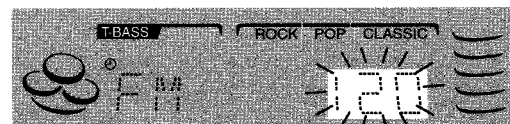

The duration will be automatically set after 4 seconds. It will also be set if II is pressed within 4 seconds after step 4.

5 Adjust the volume.

The source sound will play at the volume level set in this step when the power is turned on by the timer.

If the volume level is set to 17 or higher, however, it will automatically be set to 16 when the power is turned on.

6 Prepare the source.

To listen to a CD, load the disc to be played first on tray 1.

To listen to a tape, insert the tape into deck 1 or 2.

To listen to the radio, tune in to a station.

7 Press **POWER** to turn off the power.

☉ remains on the display after the power is turned off (timer standby mode).



8 Get ready for the **TAPE** function or the timer recording.

To listen to the tape, press ▶ on deck 1 or 2.

To record the source, insert the tape into deck 1 and press ● on deck 1.

When the timer-on time is reached, the unit turns on and begins play with the selected source.

NOTE

You can change the source that was selected in step 1 by pressing one of the function buttons before pressing II in step 3.

The timer recording period and tape length

When the length of the tape to be recorded is shorter than the timer recording period, ● on deck 1 is released before the timer is off.

When the tape length is longer than the timer recording period, ● is not released. If ● is not released for a long time, the tape in the deck may be damaged. Press ■/▲ to release ●.

To check the timer setting

Press **TIMER** while pressing **SHIFT**.

The selected source, the timer-on time, and the duration for the timer-activated period will be displayed for 6 seconds.

To change any of the previous setting

Carry out from step 1.

However, if you do not change the timer-on time, in step 3 just press II twice and continue from step 4.

To cancel the timer standby mode temporarily

Press **TIMER** while pressing **SHIFT** so that ☉ disappears.

To restore the timer standby mode, press these buttons again to display ☉.

Using the unit while the timer is set

You can use the unit normally after setting the timer.

Before turning off the power, carry out step 5 and 6.

NOTE

- Timer playback and timer recording will not begin unless the power is turned off.
- Connected equipment cannot be turned on and off by the built-in timer of this unit. Use an external timer.
- While the timer is in operation, the display indication is dimmer than usual.

BASIC OPERATIONS

CONNECTING OPTIONAL EQUIPMENT

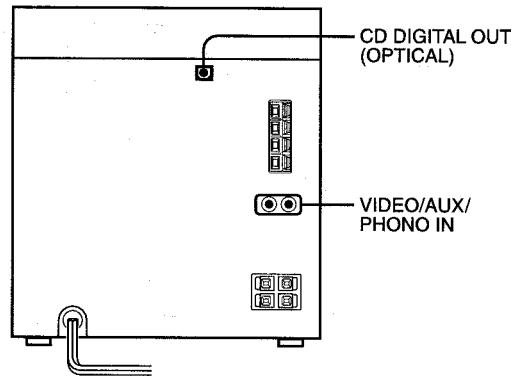
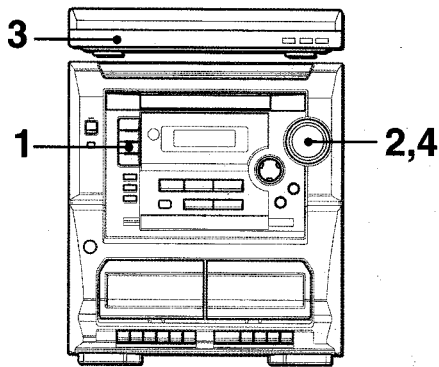

Preparation

- Connect the supplied stereo turntable to the main unit. (See page 3)
- Set **EQUALIZER AMP** on the turntable to ON position. (Refer to the operating instructions of the turntable for details.)

1 Press VIDEO/AUX/PHONO on the main unit.

"VIDEO" appears on the display.
The source name on the display can be changed to "PHONO".
(See "LISTENING TO EXTERNAL SOURCES" on page 17.)

2 Adjust the volume to minimum.

Turn **VOLUME** counterclockwise until "VOL 0" is displayed.

3 Play the turntable.

Refer to the operating instructions of the turntable for details.

4 Adjust the volume according to your preference.

Refer to the operating instructions of the connected equipment for details.

- The connecting cords are not supplied. Obtain the necessary connecting cords.
- Consult your local Aiwa dealer for optional equipment.

VIDEO/AUX/PHONO IN JACKS

This unit can input analog sound signals through these jacks. Use a cable with RCA phono plugs to connect audio equipment (LD players, MD players, VCRs, TV, etc.). Connect the red plug to **VIDEO/AUX/PHONO IN R** jack, and the white plug to **VIDEO/AUX/PHONO IN L** jack.

When connecting a turntable

Use an Aiwa turntable equipped with a built-in equalizer amplifier.

CD DIGITAL OUT (OPTICAL) JACK

This unit can output CD digital sound signals through this jack. Use an optical cable to connect digital audio equipment (DAT deck, MD recorder, etc.).

Remove the dust cap (a) from the **CD DIGITAL OUT (OPTICAL)** jack. Then, connect an optical cable plug to the **CD DIGITAL OUT (OPTICAL)** jack.

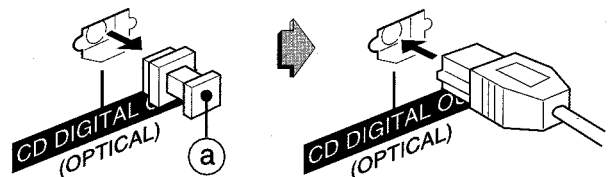

When the CD DIGITAL OUT (OPTICAL) jack is not being used

Attach the supplied dust cap.

LISTENING TO EXTERNAL SOURCES

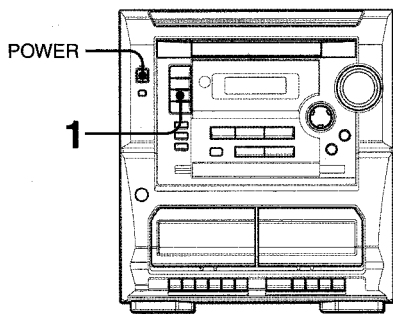

To play equipment connected to **VIDEO/AUX/PHONO IN** jacks proceed as follows.

1 Press VIDEO/AUX/PHONO.

"VIDEO" appears on the display.

2 Play the connected equipment.

To change a source name on the display

When **VIDEO/AUX/PHONO** is pressed, "VIDEO" is displayed initially. It can be changed to "AUX," "TV" or "PHONO."

With the power on, press **POWER** while pressing **VIDEO/AUX/PHONO**.

Repeat the procedure to select one of the names.

CARE AND MAINTENANCE

Occasional care and maintenance of the unit and the software are needed to optimize the performance of your unit.

To clean the cabinet

Use a soft and dry cloth.

If the surfaces are extremely dirty, use a soft cloth lightly moistened with mild detergent solution. Do not use strong solvents, such as alcohol, benzene or thinner as these could damage the finish of the unit.

To clean the tape heads

When the tape heads are dirty;

- high frequency sound is not emitted
- the sound is not adequately high
- the sound is off-balance
- the tape cannot be erased
- the tape cannot be recorded on

After every 10 hours of use, clean the tape heads with a head cleaning cassette.

Refer to the instructions of the cleaning cassette for details.

To demagnetize the tape heads

The tape heads may become magnetized after long-term use. This may narrow the output range of recorded tapes and increase noise.

After every 20 to 30 hours of use, demagnetize the tape heads with a separately sold demagnetizing cassette.

Refer to the instructions of the demagnetizing cassette for details.

Care of discs

- When a disc becomes dirty, wipe the disc from the center out with a cleaning cloth.

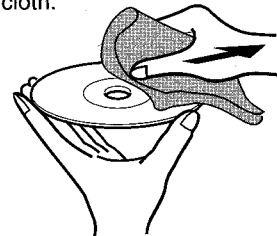

- After playing a disc, store the disc in its case. Do not leave the disc in places that are hot or humid.

Care of tapes

- Store tapes in their cases after use.
- Do not leave tapes near magnets, motors, television sets, or any source of magnetism. This will downgrade the sound quality and cause noise.
- Do not expose tapes to direct sunlight, or leave them in a car parked in direct sunlight.

TROUBLESHOOTING GUIDE

If the unit fails to perform as described in these Operating Instructions, check the following guide.

GENERAL

There is no sound.

- Is the AC cord connected properly?
- Is there a bad connection? (→ page 3)
- There may be a short circuit in the speaker terminals.
→ Disconnect the AC cord, then correct the speaker connections.
- Was an incorrect function button pressed?

Sound is emitted from one speaker only.

- Is the other speaker disconnected?

An erroneous display or a malfunction occurs.

- Reset the unit as stated below.

TUNER SECTION

There is constant, wave-like static.

- Is the antenna connected properly? (→ page 3)
- Is the signal weak?
→ Connect an outdoor antenna.

The reception contains noise interferences or the sound is distorted.

- Is the system picking up external noise or multipath distortion?
→ Change the orientation of the antenna.
→ Move the unit away from other electrical appliances.

CASSETTE DECK SECTION

The tape does not run.

- Is the deck in pause mode? (→ page 8)

The sound is off-balance or not adequately high.

- Is the playback head dirty? (→ page 17)

Recording is not possible.

- Is the erasure prevention tab on the tape broken off? (→ page 11)
- Is the recording head dirty? (→ page 17)

Erasure is not possible.

- Is the erasure head dirty? (→ page 17)
- Is a metal tape being used?

High frequency sound is not emitted.

- Is the recording/playback head dirty? (→ page 17)

CD PLAYER SECTION

The CD player does not play.

- Is the disc correctly placed? (→ page 9)
- Is the disc dirty? (→ page 17)
- Is the lens affected by condensation?
→ Wait approximately one hour and try again.

To reset

If an unusual condition occurs in the display window or the cassette decks, reset the unit as follows.

- 1 Press **POWER** to turn off the power.
- 2 Press **POWER** to turn the power back on while pressing **■CLEAR**. Everything stored in memory after purchase is canceled.

If the power cannot be turned off in step 1 because of a malfunction, reset by disconnecting the AC cord, and connect it again. Then carry out step 2.

SPECIFICATIONS

Main unit CX-ZL100

FM tuner section

Tuning range	87.5 MHz to 108 MHz
Usable sensitivity (IHF)	13.2 dBf
Antenna terminals	75 ohms (unbalanced)

AM tuner section

Tuning range	530 kHz to 1710 kHz (10 kHz step) 531 kHz to 1602 kHz (9 kHz step)
Usable sensitivity	350 μ V/m
Antenna	Loop antenna

Amplifier section

Power output	30 W + 30 W (50 Hz – 20 kHz, THD less than 1 %, 6 ohms)
--------------	---

Total harmonic distortion

0.1 % (6 W, 1 kHz, 6 ohms, DIN AUDIO)

Inputs

Outputs

VIDEO/AUX/PHONO IN: 500 mV
CD DIGITAL OUT (OPTICAL)
SPEAKERS: accept speakers of 6 ohms or more
PHONES (stereo jack): accepts headphones of 32 ohms or more

Cassette deck section

Track format

4 tracks, 2 channels stereo

Frequency response

50 Hz – 10000 Hz

Recording system

AC bias

Heads

Deck 1: Recording/playback head \times 1, erase head \times 1
Deck 2: Playback head \times 1

Compact disc player section

Laser

Semiconductor laser ($\lambda = 780$ nm)

D-A converter

1 bit dual

Signal-to-noise ratio

85 dB (1 kHz, 0 dB)

Harmonic distortion

0.05 % (1 kHz, 0 dB)

Wow and flutter

Unmeasurable

General

Power requirements

120 V AC, 60 Hz

Power consumption

56 W

Dimensions of main unit

360 \times 393 \times 342 mm

(W \times H \times D)

(14 $\frac{1}{4}$ \times 15 $\frac{1}{2}$ \times 13 $\frac{1}{2}$ in.)

Weight of main unit

7.2 kg (15 lbs 14 oz)

Speaker system SX-ZL100

Cabinet type

3 way, bass reflex

Speakers

Woofer:

130 mm (5 $\frac{1}{8}$ in.) cone type

Tweeter:

60 mm (2 $\frac{3}{8}$ in.) cone type

Super tweeter:

20 mm (1 $\frac{3}{16}$ in.) ceramic type

Impedance

6 ohms

Output sound pressure level

87 dB/W/m

Dimensions (W \times H \times D)

260 \times 496 \times 220 mm (10 $\frac{1}{4}$ \times 19 $\frac{5}{8}$ \times 8 $\frac{3}{4}$ in.)

Weight

3.7 kg (8 lbs 3 oz.)

Specifications and external appearance are subject to change without notice.

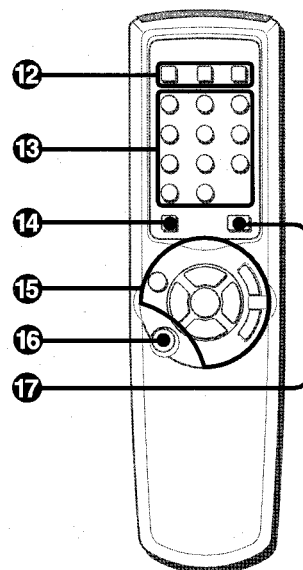
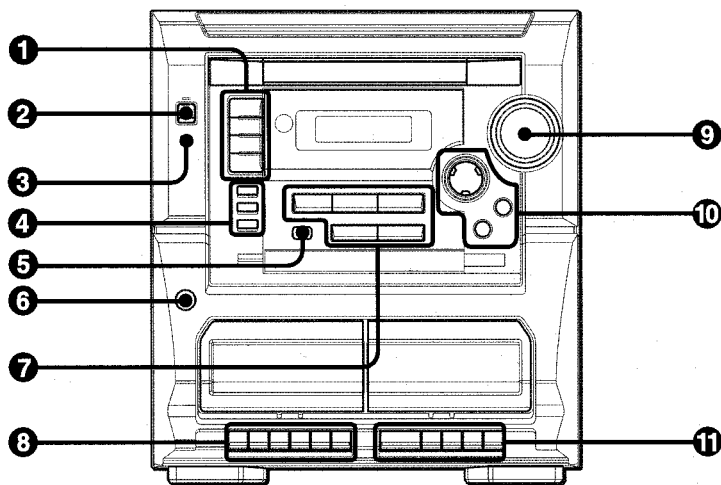

Name/Nombre/Nom Page/Página/Page

1 TAPE	8,11
TUNER/BAND	7,8,11
VIDEO/AUX/PHONO	11,16,17
CD	9,11-13
2 POWER	5,7,15,17,18
3 ECO	5,6
4 ROCK, POP, CLASSIC	7
5 T-BASS	6
6 PHONES	6
7 ◀◀/◀◀DOWN	5-10,12-15
UP▶▶/▶▶	5-10,12-15
■SET	5,6,8,9,14,15
■CLEAR	5,8-10,12-14
▶PRESET	5,7-9
8 DECK 1 (●, ▶, ◀, ▶▶, ■/▲,)	8,11-13,15
9 VOLUME	6,15,16
10 DISC DIRECT PLAY 1-3	9,10,12,13
▲OPEN/CLOSE	9,12
DISC CHANGE	9

Name/Nombre/Nom Page/Página/Page

11 DECK 2 (▶, ◀, ▶▶, ■/▲,)	8,15
12 DISC DIRECT PLAY1-3	9,10,12,13
13 0-9,+10	8-10,12,13
1/CD EDIT/CHECK	9,12,13
2/PRGM	10
3/RANDOM/REPEAT	10
4/GEQ	7
6/T-BASS	6
7/TIMER	15
8/SLEEP	14
9/CLOCK	14
0/MONO TUNER	7
+10/BAND	7,9,10,13
14 SHIFT	4
15 ▶▶/▶▶UP	5-10,12-15
◀◀/◀◀DOWN	5-10,12-15
■SET	5,6,8,9,14,15
■CLEAR	5,8-10,12-14
▶PRESET	5,7-9
VOL(∨,∧)	6,15,16
16 POWER	5,7,15,17,18
17 FUNCTION	4

For assistance and information

call toll free 1-800-BUY-AIWA (United States and Puerto Rico)